

FIRE FIGHTING



MOBILE VENTILATION

RESPONSE EQUIPMENT



LEADER

Since 1985, LEADER **has designed** and **manufactured** higher performing equipment used in **firefighting, fire training** and **Search & Rescue** applications and supplies them to Fire & Rescue Services, Civil Defense, Hazardous Industries, NGOs, Maritime Services, etc. on the five continents.

AN INTERNATIONAL PRESENCE

SUBSIDIARIES AND A STRONG NETWORK OF DISTRIBUTORS

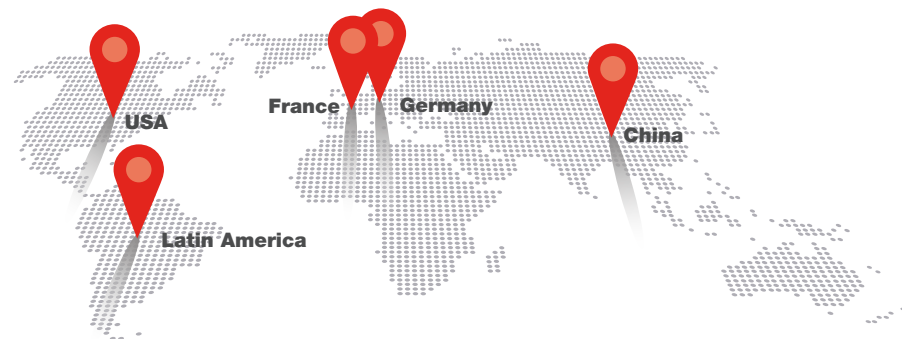

A major axis : INNOVATION

To meet the advancing challenges of fire hazards and search & rescue missions, equipment must continually **evolve** and **adapt** to be **more effective** while ensuring **maximum safety for workers**.

To meet these challenges, LEADER is committed to constant **innovation and new technologies** and has its own in-house **Research & Development** team which works alongside end-users to design and develop the equipment that will be available tomorrow.

To test our equipment and assess its performance, we at LEADER continually invest in our own infrastructure:

- ▶ Water and High-Expansion Foam test room (400 sq m)
- ▶ Ventilation test room (400 sq m)
- ▶ Casualty Search Equipment test area
- ▶ Fire test area in fire container - Fire extinguishing equipment

Our commitment

When you choose LEADER equipment, you are assured of the **quality and compliance of our products**. These have been made in our workshops by our engineering and electronics **specialists**.

ISO 9001 certified since 1999, LEADER:

- ▶ Carries out **checks** at every stage of the manufacturing process as well as on the finished products before dispatch,
- ▶ Provides **continuous training** for all its staff.

Guaranteed equipment

Every LEADER product comes with a specific contractual guarantee.

Close to our customers

Through our sales force, subsidiaries in **Germany and the USA, agencies in Latin America and China and an international distribution network**, LEADER is present worldwide, keeping us as close as possible to our customers.

An organisation at your service

For optimal and long-term use of the equipment you purchase, LEADER can propose suitable training **on the handling, on the use and maintenance of the equipment**. Training can be done at our site or at your own site.



CONTENTS

VENTILATION EQUIPMENT FOR FIRE RESPONSE AND INDUSTRIAL APPLICATIONS

EASY POW'AIR TECHNOLOGY: A LEADER CONCEPT	P8
VENTILATION TECHNIQUES FOR FIRE RESPONSE	P10
VENTILATING LARGE VOLUMES	P12
VENTILATION IN EXPLOSIVE ATMOSPHERES	P14
VENTILATION IN CONFINED SPACES	P16
THE RANGE AT A GLANCE	P6
GASOLINE-DRIVEN FANS	P18
ELECTRIC FANS	P28
WATER-DRIVEN FANS	P38
LARGE-FLOW VENTILATORS	P42
VENTILATION ACCESSORIES	P48

LEADER HAS DEVELOPED EASY POW'AIR TECHNOLOGY:

A POWERFUL, CONCENTRATED JET OF AIR: A LEADER INNOVATION

The speed and concentrated shape of the Easy Pow'Air jet catches the surrounding air, thereby increasing the fan's flow rate.

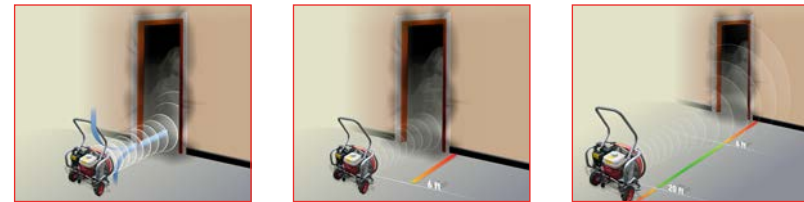

CREATES SPACE FOR RESPONSE TEAMS WORKING AROUND DOORS

The force and stability of the jet gives **constant and optimal efficiency from 6 ft to 20 ft** between fan and opening.

This creates valuable space for response teams working in /around the entrance. The fans can also be positioned as close as 3 ft.

The increased distance also reduces noise levels for responders.



SIMPLE SET-UP

Automatic +10° tilt: when raised, the lifting handle automatically positions the fan at its optimal angle of tilt.

Fine adjustment of the tilt from +10° to +20° is also possible.

EASY TO VENTILATE UP ENTRANCE STEPS

The ability to withdraw the apparatus and tilt it to its maximum angle makes ventilation possible in these situations: raised doors and windows, entrance steps, landings, etc.

Ventilation on a slope: Its optional prop allows the fan to be aimed down at an angle of -10°, making it very useful for basement work.

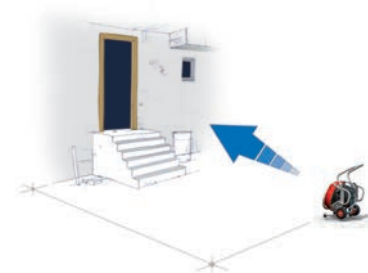

EXTENDED APPLICATIONS USING ACCESSORIES

Blowing ducts, extraction ducts, high-expansion foam adaptor, mister, etc. These options increase the number of ways a fan can be used and so circumvent the constraints of a given operation.

NEO LEADER Fan EASY POW'AIR TECHNOLOGY



INNOVATION 2015

THE NEW NEO CONCEPT FOR EVEN BETTER PERFORMING LEADER FANS!

Drawing on Easy Pow'Air technology, LEADER's engineers have developed the NEO concept:
an optimal combination of GRILLE, PROPELLER and SHROUD



The **synergy** between their technology and their aeraulic design significantly boosts the performance of the 16.5 inch diameter gasoline-driven, electric, and water-driven fans of the LEADER range.

Up to 20% greater flow rate, for unrivalled power in their category!

An operational advantage for the firefighter:

NEO concept employs compact and lightweight fans with performances until now obtained by higher category fans.



VERIFIED PERFORMANCE

LEADER has its own test center with an instrumented "test house" including a dedicated room for measuring flow rates and pressures to standard AMCA 240-06.

To allow for the variability of real life situations, the test house incorporates multiple features allowing fans to be tested and compared.

This installation is indispensable to our R&D department for testing and developing innovations to LEADER fans and maximizing their performance. The test house also allows us to demonstrate to customers and partners the efficiency of our fans and the firefighting benefits of controlling ventilation.

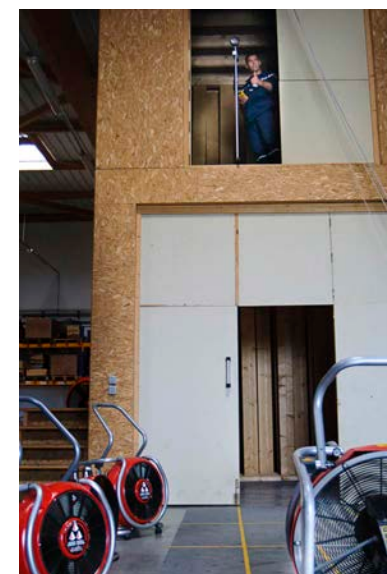

CONTROL THE AIR AND YOU CONTROL THE FIRE!

ASSOCIATED VENTILATION TECHNIQUES:

POSITIVE PRESSURE VENTILATION (PPV)

Blowing a large quantity of fresh air into a fire-affected space raises the internal pressure, allowing the smoke to be controlled.

The effects are rapidly obvious: Increased visibility, lowered temperature, reduced toxicity, control of smoke movement and reduced calorific potential. These effects are beneficial to responders and trapped persons alike.

Firefighters must decide which fan or fans will be best in a given situation, depending on the layout of the premises to be ventilated.



OFFENSIVE PPV TACTIC

The offensive tactic is direct ventilation of the volume in which the fire is developing, combined with fire extinguishing resources. This tactic aims to modify the behavior of the fire and quickly reduce its intensity.

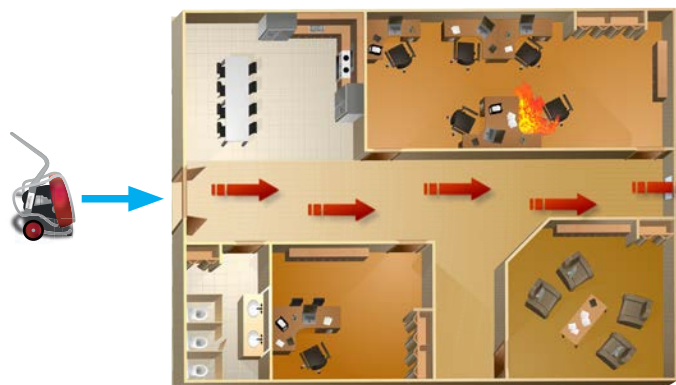

DEFENSIVE PPV TACTIC

This defensive tactic protects particular areas. It prevents smoke and hot gases propagating to locations that are to be protected.

Only volumes not affected by fire are ventilated. This tactic employs ventilation dissociated from fire-extinguishing actions. It creates a logistical route with a slightly higher air pressure through which, for example, victims can be evacuated.

COMBINED VENTILATION TACTICS

Also known as operational ventilation, this combined tactic involves using both the preceding tactics on high-rise tower blocks:

1/ Defensive ventilation is first deployed using a high-power "master" fan positioned at the foot of the building facing its entrance.

2/ With the stairwell pressurized and thus made safe, the intervention team climbs up to the affected floor to set up a portable relay fan at the entrance of the burning volume.

3/ Once the exit is created, the offensive phase can begin: The air flow from the master fan is relayed by the secondary fan, which is on the affected floor, and pushes the hot toxic smoke out of the building so that the combustible components of the smoke cannot spread. Smoke control facilitates the work of the teams, especially the fire extinguishing team.

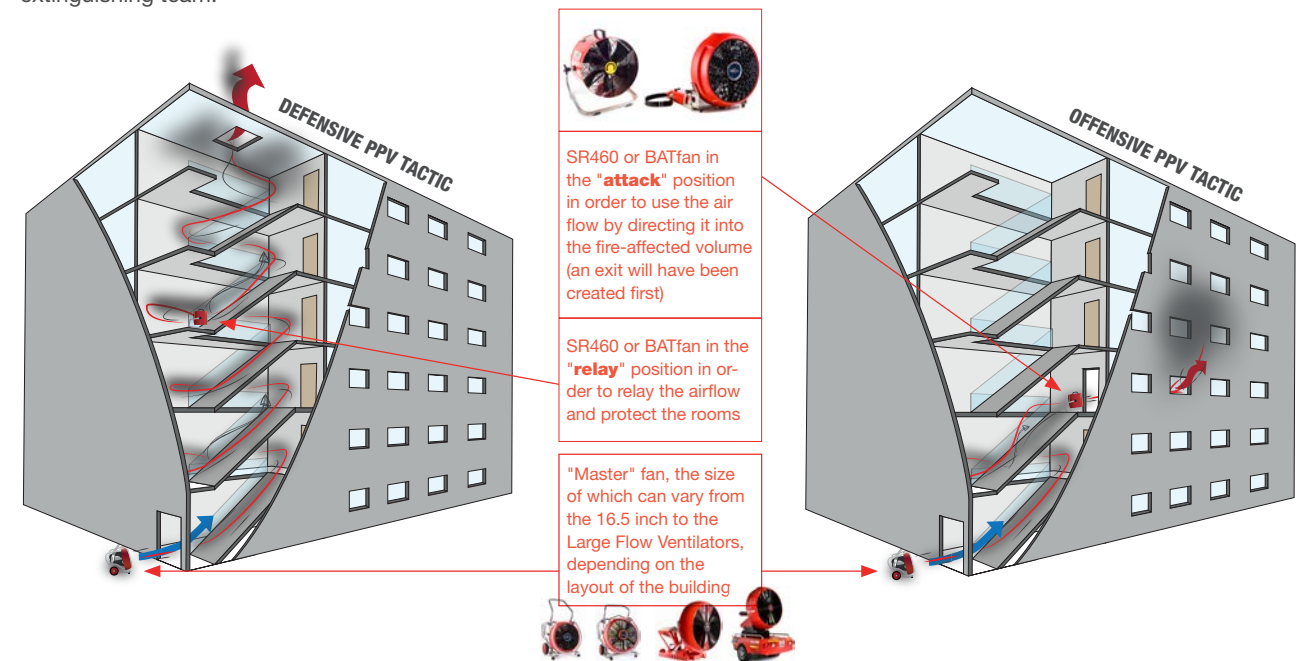

NEGATIVE PRESSURE VENTILATION (NPV)

This involves lowering the pressure inside the volume. The fan is placed inside the smoke-filled area and blows the smoke to the exterior. Simultaneously the crew create a fresh air inlet opening on the opposite side. A continuous stream of air then evacuates all smoke. NPV is used in a variety of situations, primarily where conditions and location do not favor natural ventilation or positive-pressure ventilation.

This method is particularly effective on fires in covered parking lots, underground tunnels/stations, basements and cellars.

The ParkFan 80 was designed as an efficient, easy-to-implement solution for smoke removal from covered parking lots.

With their combination of performance and maneuverability, these fans remain unequalled.

A single crewmember can easily deploy 1 or 2 ParkFans inside the smoke-filled volume and direct the airstream and smoke out of the premises.

Accessories such as extraction ducts or suction/blow kits convert fans designed for PPV into extractors of smoke from confined spaces (cellars, basements etc.) or large volumes such as parking lots by using the Easy 4000 LFW fan and its extraction ducts.



LFV: LARGE-FLOW VENTILATORS

MOBILE SOLUTION FOR VENTILATING LARGE VOLUMES

Large buildings continue to proliferate and are becoming ever larger. To meet these challenges, LEADER has designed large-flow ventilators to effectively fight fires in very large places such as Warehouses, Tunnels, Airports, Industrial Complexes, High-Rise Tower Blocks, etc.



ASSURED RESULTS

Being totally independent of fixed fire-protection systems, these large-flow ventilator units are mobile and capable of mass ventilating enormous volumes.

EASILY MANEUVERED BY ONE PERSON

LEADER trailer-mounted LFVs are easily maneuvered and positioned by one person.

Their combination of weight, power and maneuverability give these LFVs unequalled effectiveness.

ADAPTABLE TO VEHICLES OF ALL TYPES

Fans are available in trailer and skid versions for mounting on any mobile intervention unit.

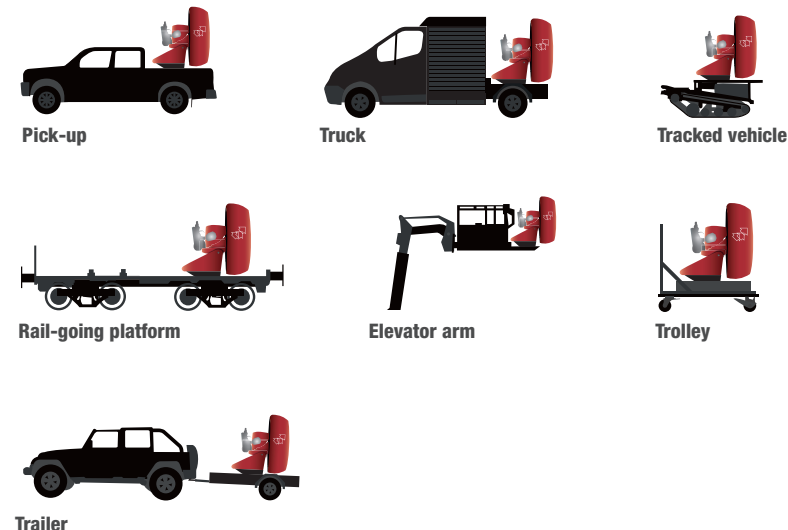

CHOOSING THE RIGHT APPARATUS TO VENTILATE LARGE STRUCTURES

To meet the diverse needs of fire response or industrial applications, LEADER has developed large-flow ventilators:



	Easy 2000	Easy 4000
Effectiveness	Open air flow 88,285 CFM	Open air flow 235,430 CFM
Application	<p>One fan is an effective means of ventilating more modest large volumes such as industrial units, medium height/tall buildings, underground parking lots etc.</p> <p>Multiple fans offer flexibility of action since they can be used simultaneously to optimize blowing power. They can also be positioned at strategic points around a city or town.</p>	<p>For ventilating very large volumes tunnels, industrial buildings, very tall buildings, airport buildings, etc.</p>

VARIED VENTILATION APPLICATIONS REQUIRING LARGE BLOWING POWER

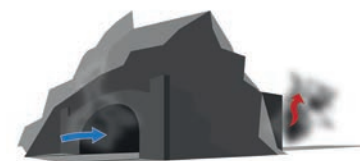

Road or rail tunnel ventilation
Sets up an air stream if the fixed ventilation system is defective, or boosts it if it is working, to expel smoke from the tunnel, refresh the volume, and intervene more efficiently.



Ventilation of airplanes and other aircraft
Valuable assistance when evacuating passengers. Quickly brings in fresh air and increases visibility in a restricted space where smoke can rapidly cut visibility to zero.

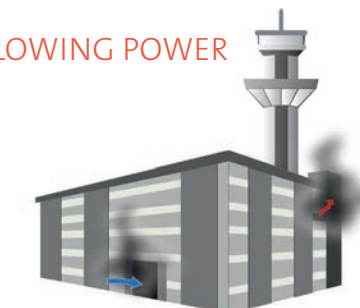

Airport ventilation
Airports contain many very large interconnected halls and need the ability to remove harmful smoke rapidly to prevent it spreading and enable the rest of the airport to continue operating.



Ventilation of smoke-generating factories
Production stoppages can be very costly. Fixed smoke capture systems can be overwhelmed to the point where production grinds to a halt. An LFV is a mobile independent low-cost solution for occasional use, accelerating smoke removal times for industrial sites.



Ventilation of shopping centers
These very often consist of one large shop and connected shopping walkways. In such large spaces smoke can spread rapidly. It is important to be able to remove the smoke quickly, both to protect people and to safeguard merchandise.

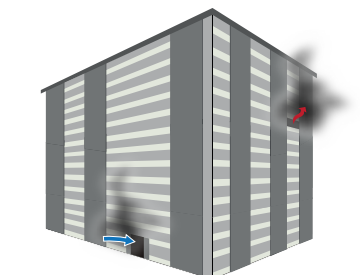

Ventilation of tall tower blocks
The varied configurations of buildings often require large blowing power to create an air stream sufficient to pressurize the stairwell right up to the top floor. The larger the building, the greater the number of openings through which pressure can be lost. Pressurizing the total volume is therefore more effective with an LFV.



Ventilation of covered parking lots
Extraction ducts allow LFV to remove smoke from underground parking lots.

ATEX MOBILE VENTILATION



FOR RISK-FREE USE IN EXPLOSIVE ATMOSPHERES.

To meet the need for mobile ventilation in at-risk industries, LEADER has designed special fans incorporating the most frequently requested features for use in explosive atmospheres to meet the requirements laid down in the ATEX Directive 94/9/EC and standard EN 14986-2007 specifically about fans.

There are no exceptions to the latter and a certificate must accompany every machine sold. The directive covers electrical and mechanical equipment designed to be used in potentially explosive atmospheres within the European Union and applies to all manufacturers worldwide.

THE ENTIRE APPARATUS MUST BE ATEX-CERTIFIED

An isolated component such as an ATEX-certified motor is not sufficient to obtain certification. LEADER fans are tested to the standards listed in the ATEX Directive. Their certification covers the entirety of the unit - motor, frame, shroud, grille, propeller, electronic module with its power supply cable, wheels, etc.



VARIOUS MOBILE FAN APPLICATIONS IN INDUSTRY

- Pressurizing a volume to make it safe,
- Expelling harmful smoke,
- Cooling an overheating machine,
- Removing smoke, explosive or toxic gases,
- etc.

INTERPRETING THE ATEX CLASSIFICATION

The following information explains the ATEX classification, taking the ID plate of the ESX230 as an example.

So as not to limit your field of action in an explosive area, choose category 1- or 2-certified products.

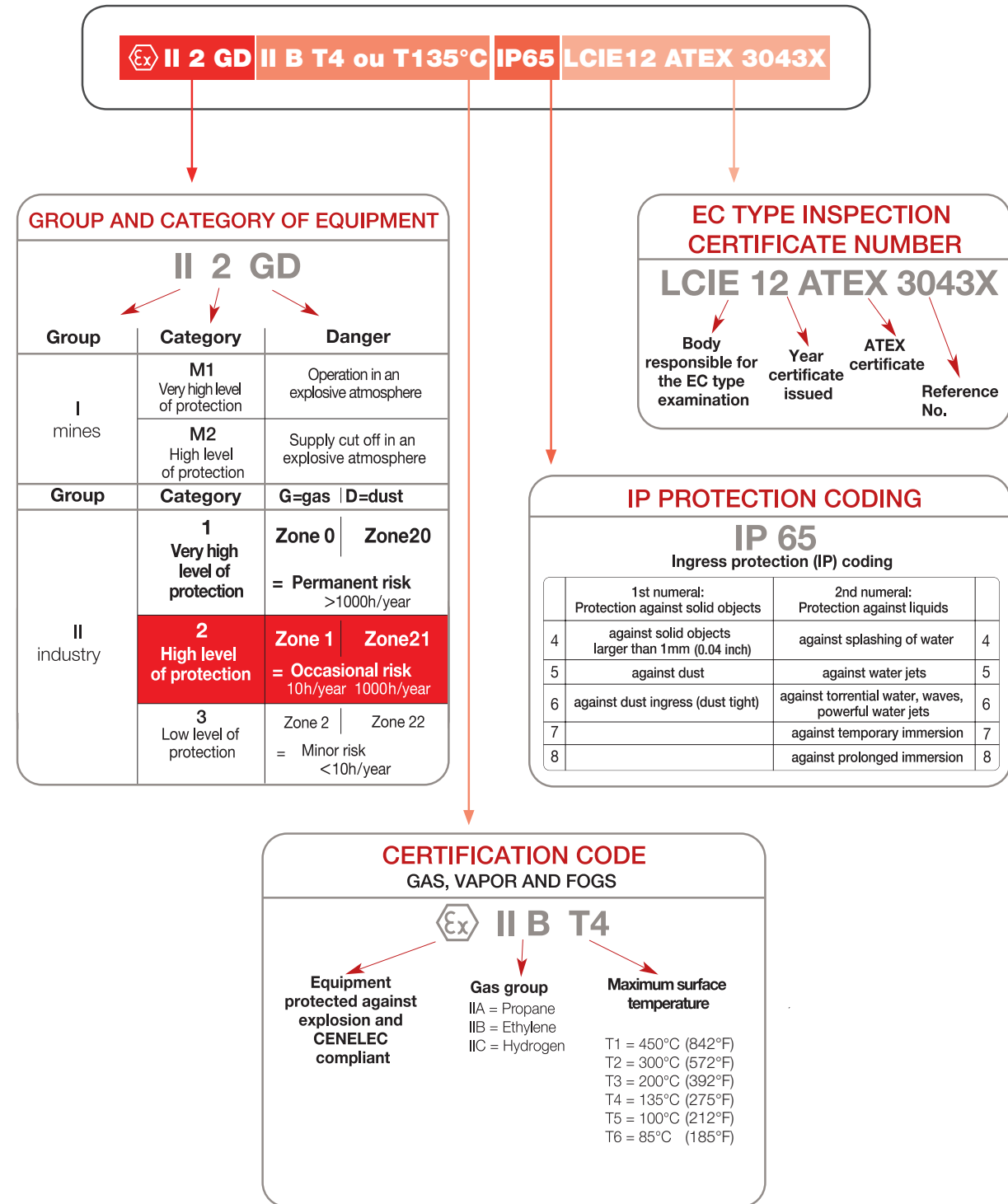



RISKS IN CONFINED SPACES

Aside from general risks, confined space work exposes responders to three kinds of risk:

- ▶ asphyxiation
- ▶ poisoning
- ▶ fire and explosion

There are several processes that can reduce the oxygen concentration in a confined space: The oxygen is consumed, a blanket gas is introduced, or a gas of natural origin is released.



V-Box extractor/blower conversion kit

CLEANING THE AIR BY VENTILATION

It is possible to mitigate the causes of oxygen deficiency with ventilation techniques:

- ▶ by capture if the pollution source is localized - extracting bad air directly from close to its source,
- ▶ by dilution if the pollution source is diffused: Preferably extraction if a small volume, blowing if a larger volume.

By blowing, whether directly or through blowing ducts, LEADER fans enable responders to:

- ▶ introduce new air
- ▶ cool a volume
- ▶ expel toxic gases or smoke from the structure
- ▶ pressurize a volume, thereby preventing the smoke or gases from spreading

By suction using dedicated accessories (ducts and extraction/blow kits), the LEADER range of electric fans can extract toxic gases or smoke where the blowing technique is not suitable.

TRAINING LEADER SHARES ITS EXPERT VENTILATION EXPERIENCE



TAILOR-MADE TRAINING

LEADER regularly organises fire ventilation training courses around the world and at fire departments' request, where we teach the basics of the use of positive and negative pressure ventilation (PPV and NPV).

The different ventilation techniques are presented and practical sessions held to put the theory into practice.

Courses can be held:

- ▶ at LEADER's premises, with the advantage of being able to use the "test house", used by the R&D team on a daily basis to test our own fans,
- ▶ at the fire department's site,
- ▶ at a dedicated training site.



TEACHING SOFTWARE FOR FIRE VENTILATION TRAINING

LEADER has developed software consisting of interactive courses that can be freely downloaded from its website.

Created in partnership with the well-known fire training organisation EducExpert, these lessons are specially designed to be used by fire instructors in their task of passing on the skills of implementing ventilation techniques.

COMPLETE, EFFECTIVE LESSONS

Downloadable in 4 languages (English, French, Spanish and Chinese), these lessons introduce three main topics:

- ▶ The basics of three key firefighting ventilation techniques (offensive, defensive and combined ventilation),
- ▶ A review of the underlying principles of fire and the different phases of fire development,
- ▶ Thermal phenomena and their consequences.

BETTER ASSIMILATION OF KNOWLEDGE

Interactive lessons! Through the use of animations and clickable buttons, learners feel more engaged and therefore remember better.

OPTIMIZED LEARNING TIME

When used as part of the broader training of firefighters, it enables more efficient assimilation of knowledge.

ERGONOMIC

Quality, simplicity and user-friendliness are other advantages students appreciate.

TEST WHAT STUDENTS HAVE LEARNED

Each lesson unit includes a self-assessment section consisting of questionnaires and practical interactive exercises for rapid validation of what trainees have learned.





A RANGE OF POWERFUL FANS:



GASOLINE-DRIVEN FANS

Model	Outlet Ø in inch	Ventilation type	Application*	Motor**	Open air flow in CFM	Flow rate in CFM according to AMCA 240-06	Weight in lbs	See details page
MT 215 L NEO	16.5	PPV	1	Honda GXH50 - 2.1 HP	16,950	13,690	44.7	p20
MT 225 NEO	16.5	PPV	1	Honda GX120 - 3.6 HP	22,190	-	59.1	p21
MT 236 NEO	16.5	PPV	1	Honda GX160 - 4.8 HP	30,400	19,810	87.3	p22
MT 240 NEO	16.5	PPV	1	Honda GX200 - 5.5 HP	33,050	21,355	91.9	p23
MT 245	22.4	PPV	1-2	Honda GX200 - 5.5 HP	30,135	-	114.6	p24
MT 280	22.4	PPV	1-2	Honda GX390 - 11.7 HP	50,150	-	153	p35
MT 296	22.4	PPV	1-2	B&S-Vanguard - 16 HP	56,505	-	169.1	p26
Easy 2000	34.8	PPV LfV	2-3	Honda GX630 - 20.8 HP	88,290	-	663.6	p48
Easy 4000	47.2	PPV LfV	3	BMW - 115 HP	235,430	-	1,206	p50

ELECTRIC FANS

ON BATTERY

BAT FAN NEO	16.5	Relay and PPV	1	600 W (0.8 HP) - 110v / 220v - 50Hz / 60Hz	14,155	8,850	54.4	p30
-------------	------	---------------	---	--------------------------------------------	--------	-------	------	-----

DIRECT START

SA315	11.8	Extraction	1	1.1 kW (1.5 HP) - 220v - 50Hz	5,300	-	65.7	p40
SR460	15.7	Relay and PPV	1	375 W (0.5 HP) - 220v - 50Hz / 60 Hz	7,650	-	34.2	p32
ES 220 NEO	16.5	PPV	1	1.5 kW (2 HP) - 220v - 50Hz	18,365	12,570	57.1	p33
ES 230 NEO	16.5	PPV	1	2.2 kW (3 HP) - 220v - 50Hz	23,985	15,975	86.6	p34
EDS 230 NEO	16.5	PPV	1	1,1 kW (1,5 HP) - 15 amp - 110v - 60Hz	16,920	11,625	73	p35
EDS 230.2 NEO	16.5	PPV	1	1,5 kW (2 HP) - 20 amp - 110v - 60Hz	19,070	12,830	81.6	p35
ES 245	22.4	PPV	1-2	2.2 kW (3 HP) - 220v - 50Hz	24,425	16,745	111.3	p37

WITH SOFT STARTER

ESP 230 NEO	16.5	PPV	1	2.2 kW (3 HP) - 220v - 50Hz	23,985	15,975	88.2	p34
ESP 280	22.4	PPV	1-2	7.5 kW (10 HP) - 400v - 50Hz	50,440	-	164.5	p38

WITH VARIABLE-SPEED DRIVE

ESV 230 NEO	16.5	PPV	1	2.2 kW (3 HP) - 220v - 50Hz / 60 Hz	23,985	15,975	90.4	p34
EVG 230 NEO	16.5	PPV	1	1.1 kW (1.5 HP) - 15 amp - 110v - 50Hz / 60Hz	17,010	11,625	78.3	p35
ESV 245	22.4	PPV	1-2	2.2 kW (3 HP) - 220v - 50Hz / 60 Hz	24,425	16,745	116.8	p37
ESV 280	22.4	PPV	1-2	7.5 kW (10 HP) - 400v - 50Hz / 60Hz	50,440	-	179.5	p38
PARK FAN 80	22.4	NPV or PPV	1-2	7.5 kW (10 HP) - 400v - 50Hz / 60 Hz with wireless remote control	50,440	-	183	p39

ATEX

SAX 320	11.8	Extraction	1	1.1 kW - 110v / 220v - 50Hz / 60Hz	5,300	-	92.6	p41
ESX 230	16.5	PPV	1	1.85 kW (2.5 HP) - 400v - 50Hz / 60Hz	17,655	11,185	125.6	p36

WATER-DRIVEN FANS

MH 236 NEO	16.5	PPV	1	9 HP	28,870	-	71.9	p44
MH 260	22.4	PPV	2	9 HP	29,725	-	108	p45

*Application :

- 1 - Ventilation through single-leaf door, e.g. houses, small blocks of flats ...
- 2 - Ventilation through single/double doors, e.g. high-rise tower blocks, medium-size industrial units ...
- 3 - Ventilation through industrial unit door, underground parking lots, industrial sites, tunnels etc.

PPV = Positive Pressure Ventilation

NPV = Negative Pressure Ventilation

Relay = Relay fan in a combined ventilation set-up

LfV = Large-Flow Ventilator

**Electric motor = power in W measured on the shaft



Gasoline-driven fans



Have the advantage of containing their own power source and have great blowing power. LEADER offers a complete range of fans of different powers.



NEO
LEADER Fan
EASY POW'AIR
TECHNOLOGY

GASOLINE-DRIVEN FAN MT215 L

Compact and lightweight: 44.7 lbs!

A very **concentrated and ultra-powerful** jet of air due to an optimal combination of:

- ▶ A high-strength propeller matched to the power of the engine
- ▶ A red double-layer monobloc shroud made of reinforced high-density polyethylene
- ▶ A high-tech composite grille

Positioning from 3 ft to 20 ft in front of a door without loss of power for:

- ▶ more space to move about
- ▶ less noise inside the building

With folding pull/steer handle for easier set-up

Characteristics

Model	MT215 L NEO
Reference	I60.10.062N
Open air flow	16,950 CFM
PPV air flow according to AMCA	13,690 CFM
Weight (dry)	44.7 lbs
Dimensions L x H x D	20.9 x 19.5 x 21.9 inch
Propeller diameter	16.5 inch
Run time at full speed	1h40
Engine	HONDA GXH50 engine (4-stroke) 56% less CO than a 5 HP engine Assembly inspected and approved by Honda Motor Co., Ltd
Engine power	2.1 HP according to standard SAE J1349 of 2007
Noise level	84,5 dB at 10 ft
Ventilation type	PPV blowing
Application	Single door, e.g. house, small apartment block

Optional accessories:

High expansion foam adapter without coupling delivered with 114.8 ft of polyane plastic film duct (products with coupling: see p. 52)	I60.20.105
Hour meter	I60.20.135
Adapter for connecting ventilation duct to fan	I60.20.149
16.4 ft ventilation duct	I60.20.147



NEO
LEADER Fan
EASY POW'AIR
TECHNOLOGY

GASOLINE-DRIVEN FAN MT225

A very **concentrated and ultra-powerful** jet of air due to an optimal combination of:

- ▶ A high-strength propeller matched to the power of the engine
- ▶ A red double-layer monobloc shroud made of reinforced high-density polyethylene
- ▶ A high-tech composite grille

Positioning from 3 ft to 20 ft in front of a door without loss of power for:

- ▶ more space to move about
- ▶ less noise inside the building

Precise tilt adjustment from -10° to +20° with indicator for optimization of direction of air stream up entrance steps or down into a semi-basement

Protective frame with gray epoxy coating

Compact for easy storage in vehicle trunks

Characteristics

Model	MT225 NEO
Reference	I60.10.054N
Open air flow	22,190 CFM
PPV air flow according to AMCA	-
Weight (dry)	59.1 lbs
Dimensions L x H x D	21.6 x 22.4 x 17.2 inch
Propeller diameter	16.5 inch
Run time at full speed	1h40
Engine	HONDA GX 120 engine (4-stroke) Automatic engine cutout if oil runs out. Assembly inspected and approved by Honda Motor Co., Ltd
Engine power	3,6 HP according to standard SAE J1349 of 2007
Noise level	94,8 dB at 10 ft
Ventilation type	PPV blowing
Application	Single door, e.g. house, small apartment block

Optional accessories:

Mister without coupling (products with coupling: see p. 52)	Consult us
High expansion foam adapter without coupling delivered with 114.8 ft of polyane plastic film duct (products with coupling: see p. 52)	I60.20.105
16.4 ft ventilation duct	I60.20.147
Adapter for connecting ventilation duct to fan	I60.20.149



NEO
LEADER Fan
EASY POW'AIR
TECHNOLOGY

GASOLINE-DRIVEN FAN MT236

A very **concentrated and ultra-powerful** jet of air due to an optimal combination of:

- ▶ A high-strength propeller matched to the power of the engine
- ▶ A red double-layer monobloc shroud made of reinforced high-density polyethylene
- ▶ A high-tech composite grille

Positioning from 3 ft to 20 ft in front of a door without loss of power for:

- ▶ more space to move about
- ▶ less noise inside the building

Automatic optimal +10° tilt when handle raised

Characteristics

Model	MT236 NEO	
Reference	I60.10.052N	I60.10.053N
Open air flow	30,400 CFM	
PPV air flow according to AMCA	19,810 CFM	
Weight (dry)	87.3 lbs	
Dimensions L x H x D	21.6 x 22 x 19.3 inch	
Propeller diameter	16.5 inch	
Run time at full speed	2h10	
Engine	HONDA GX 160 engine (4-stroke) Automatic engine cutout if oil runs out. Assembly inspected and approved by Honda Motor Co., Ltd	
Engine power	4.8 HP according to standard SAE J1349 of 2007	
Noise level	93 dB at 10 ft	
Ventilation type	PPV blowing	
Application	Single door, e.g. house, small apartment block	
-10° prop for negative tilt of fan	No	Yes

Optional accessories:

CO-reducing LEADER Cat catalytic converter	I60.20.142	Exhaust adapter	I60.20.014
Mister without coupling (products with coupling: see p. 52)	I60.20.104	Exhaust extension (length: 8.2 ft)	I60.20.012
High expansion foam adapter without coupling delivered with 114.8 ft of polyane plastic film duct (products with coupling: see p. 52)	I60.20.105	Protective cover	I60.20.017
Hour meter	I60.20.135	-10° prop for negative tilt of fan	I60.20.130
16.4 ft ventilation duct	I60.20.101		



NEO
LEADER Fan
EASY POW'AIR
TECHNOLOGY

GASOLINE-DRIVEN FAN MT240

A very **concentrated and ultra-powerful** jet of air due to an optimal combination of:

- ▶ A high-strength propeller matched to the power of the engine
- ▶ A red double-layer monobloc shroud made of reinforced high-density polyethylene
- ▶ A high-tech composite grille

Positioning from 3 ft to 20 ft in front of a door without loss of power for:

- ▶ more space to move about
- ▶ less noise inside the building

Automatic optimal +10° tilt when handle raised

Characteristics

Model	MT240 NEO	
Reference	I60.10.060N	
Open air flow	33,050 CFM	
PPV air flow according to AMCA	21,355 CFM	
Weight (dry)	91.9 lbs	
Dimensions L x H x D	21.6 x 22 x 19.3 inch	
Propeller diameter	16.5 inch	
Run time at full speed	1h30	
Engine	Engine HONDA GX 200 (4-stroke) Automatic engine cutout if oil runs out. Assembly inspected and approved by Honda Motor Co., Ltd	
Engine power	5.5 HP according to standard SAE J1349 of 2007	
Noise level	93 dB at 10 ft	
Ventilation type	PPV blowing	
Application	Single door, e.g. house, small apartment block	

Optional accessories:

CO-reducing LEADER Cat catalytic converter	I60.20.142	Exhaust adapter	I60.20.014
Mister without coupling (products with coupling: see p. 52)	I60.20.104	Exhaust extension (length: 8.2 ft)	I60.20.012
High expansion foam adapter without coupling delivered with 114.8 ft of polyane plastic film duct (products with coupling: see p. 52)	I60.20.105	Protective cover	I60.20.017
Hour meter	I60.20.135	16.4 ft ventilation duct	I60.20.101



LEADER Fan
EASY POW'AIR
TECHNOLOGY

GASOLINE-DRIVEN FAN MT245

A concentrated, powerful jet of air due to:

- ▶ high-strength propeller matched to the power of the motor
- ▶ double-layer aluminum/ABS thermoplastic red shroud
- ▶ metal grille

Positioning from 3 ft to 20 ft in front of a door without loss of power for:

- ▶ more space to move about
- ▶ less noise inside the building

Automatic optimal +10° tilt when handle raised

Precise tilt adjustment

from +10° to +20° for optimization of direction of air stream up entrance steps

Protective frame

with gray epoxy coating

Stable & easy to handle with large rear wheels

Characteristics

Model	MT245
Reference	I60.10.051
Open air flow	30,135 CFM
PPV air flow according to AMCA	-
Weight (dry)	114.6 lbs
Dimensions L x H x D	27.9 x 28.3 x 24.3 inch
Propeller diameter	22.4 inch
Run time at full speed	2h00
Engine	HONDA GX 200 (4-stroke) Automatic engine cutout if oil runs out. Assembly inspected and approved by Honda Motor Co., Ltd
Engine power	5.5 HP according to standard SAE J1349 of 2007
Noise level	96 dB at 10 ft
Ventilation type	PPV blowing

Optional accessories:

CO-reducing LEADER Cat catalytic converter	I60.20.142	Exhaust adapter	I60.20.014
Mister without coupling (products with coupling: see p. 52)	I60.20.104	Exhaust extension (length: 8.2 ft)	I60.20.012
High expansion foam adapter without coupling delivered with 114.8 ft of polyane plastic film duct (products with coupling: see p. 52)	I60.20.116	Protective cover	I60.20.097
Hour meter	I60.20.135	-10° prop for negative tilt of fan	I60.20.108
16.4 ft ventilation duct	I60.20.113		



LEADER Fan
EASY POW'AIR
TECHNOLOGY

GASOLINE-DRIVEN FAN MT280

A concentrated, powerful jet of air due to:

- ▶ high-strength propeller matched to the power of the motor
- ▶ double-layer aluminum/ABS thermoplastic red shroud
- ▶ metal grille

Positioning from 3 ft to 20 ft in front of a door without loss of power for:

- ▶ more space to move about
- ▶ less noise inside the building

Automatic optimal +10° tilt when handle raised

Precise tilt adjustment

from +10° to +20° for optimization of direction of air stream up entrance steps

Protective frame

with gray epoxy coating

Stable & easy to handle with large rear wheels

Characteristics

Model	MT280
Reference	I60.10.048
Open air flow	50,150 CFM
PPV air flow according to AMCA	-
Weight (dry)	153 lbs
Dimensions L x H x D	27.9 x 28.3 x 24.3 inch
Propeller diameter	22.4 inch
Run time at full speed	1h20
Engine	HONDA GX 390 (4-stroke) Automatic engine cutout if oil runs out. Assembly inspected and approved by Honda Motor Co., Ltd
Engine power	11.7 HP according to standard SAE J1349 of 2007
Noise level	99 dB at 10 ft
Ventilation type	PPV blowing
Application	Single door (e.g. house, small apartment block) and double door (e.g. tall apartment block, mid-size industrial unit)

Optional accessories:

Mister without coupling (products with coupling: see p. 52)	I60.20.104	Exhaust adapter (products with coupling: see p. 52)	I60.20.125
High expansion foam adapter without coupling delivered with 114.8 ft of polyane plastic film duct (products with coupling: see p. 52)	I60.20.116	Exhaust extension (length: 8.2 ft)	I60.20.012
Hour meter	I60.20.135	Protective cover	I60.20.097
16.4 ft ventilation duct	I60.20.113	-10° prop for negative tilt of fan	I60.20.108



LEADER Fan
EASY POW'AIR
TECHNOLOGY

GASOLINE-DRIVEN FAN MT296

A concentrated, powerful jet of air due to:

- ▶ high-strength propeller matched to the power of the motor
- ▶ double-layer aluminum/ABS thermoplastic red shroud
- ▶ metal grille

Positioning from 3 ft to 20 ft in front of a door without loss of power for:

- ▶ more space to move about
- ▶ less noise inside the building

Precise tilt adjustment

from +10° to +20° for optimization of direction of air stream up entrance steps

Protective frame

with gray epoxy coating

Stable & easy to handle with large rear wheels

Automatic optimal +10° tilt when handle raised

Characteristics

Model	MT296
Reference	I60.10.045
Open air flow	56,505 CFM
PPV air flow according to AMCA	-
Weight (dry)	169.1 lbs
Dimensions L x H x D	27.9 x 30.7 x 26.7 inch
Propeller diameter	22.4 inch
Run time at full speed	1h50
Engine	B&S Vanguard two-cylinder engine (4-stroke)
Engine power	16 HP according to standard SAE J1349 of 2007
Noise level	98.3 dB at 10 ft
Ventilation type	PPV blowing
Application	Single door (e.g. house, small apartment block) and double door (e.g. high rise buildings, mid-size industrial unit)

Optional accessories:

16.4 ft ventilation duct	I60.20.113	Exhaust extension (length: 8.2 ft)	I60.20.012
Mister without coupling (products with coupling: see p. 52)	I60.20.111	Protective cover	I60.20.097
High expansion foam adapter without coupling delivered with 114.8 ft of polyane plastic film duct (products with coupling: see p. 52)	I60.20.116	-10° prop for negative tilt of fan	I60.20.108
Hour meter	I60.20.135		



Ventilation tactics in the catalogue or at www.LeaderNorthAmerica.com
 Freely downloadable interactive ventilation courses at www.leader.educexpert.com
 As part of our policy of constant research to improve our products, we reserve the right to modify our products' characteristics at any time without notice



Electric fans



Have the advantage of not producing any toxic fumes and are quieter than gasoline-driven engines. However, they need a power supply which must be allowed for ahead of time based on their power and the number of fans deployed.

LEADER offers a complete range of electric fans of different powers with or without variable speed drive and suitable for differing electricity supplies (110/220 V, 50/60 Hz, GFCI (RCD), soft starter, etc.).



ELECTRIC FAN BATfan

Portable battery-mounted fan
Powerful and lightweight for completely self contained operation!

2 versions to choose from:

- ▶ BATfan 20 with a 20-minute runtime and total weight of 54.4 lbs
- ▶ BATfan 45 with a 45-minute runtime and total weight of 61.7 lbs

Totally self-contained

- ▶ No cables: Avoids further accidents
- ▶ No need for a generator or power socket

Compact & mobile

- ▶ Folds up and stows easily in the trunk of a vehicle: 2 BATfans occupy the space of one conventional fan!
- ▶ Portable by one person alone
- ▶ Carrying handle and strap
- ▶ Folding trolley for even easier transport (optional)

Quicker to set up than conventional fans

- ▶ No time wasted searching for a power socket: Starts off instantly
- ▶ Easy set-up

Powerful concentrated jet of air with optimal combination of:

- ▶ propeller specifically matched to the motor power
- ▶ reinforced double-layer monobloc shroud
- ▶ high-tech composite grille

Positioning from 3 ft to 20 ft in front of a door

Dual power source means greater flexibility:

Runs on battery or mains electricity if necessary (battery will automatically recharge at same time)

Practical

- ▶ Tilt is adjustable from -10° to +30° due to locking system with angle indicator
- ▶ Integrated variable-speed drive
- ▶ Powered by NiMH battery
 - Can recharge while in use
 - Low maintenance: 1 full recharge every 6 weeks
 - No restrictions on air transport
 - Battery charge indicator



Electric fan

- ▶ No exhaust gases
- ▶ Noise level lower than a gasoline-driven engine

Multi-use, can be used:

- ▶ indoors or outdoors: protected against splashing water (IP55)
- ▶ on its own at a building entrance for PPV
- ▶ for PPV combined tactics with other fans:
 - as a relay in a corridor or stairwell
 - for attack in front of an apartment door for offensive ventilation
- ▶ in blowing mode with duct (optional)
- ▶ as a foam generator with adapter (optional)

Two BATfans together for even more flexibility

Taking up no more space than one standard fan, two BATfans give greater operational flexibility:

- ▶ at the building entrance for PPV tactic for more air flow
- ▶ for combined PPV tactic: one at the entrance, the other as relay or attack on a higher floor of a building

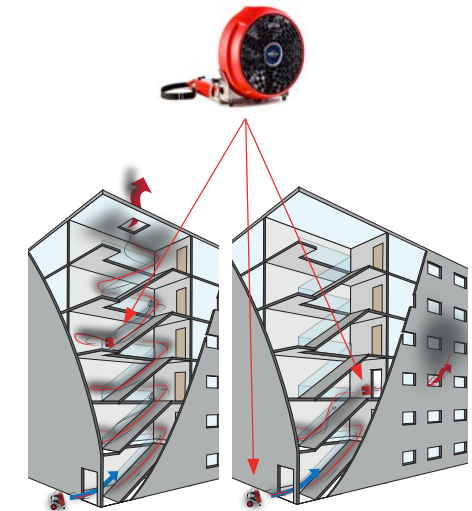

Characteristics

Model	BATfan 20	BATfan 45
References 110V	163.12.001N	163.12.004N
References 220V	163.12.002N	163.12.003N
Open air flow	14,155 CFM	
PPV air flow according to AMCA	8,850 CFM	
Weight	54.4 lbs	61.7 lbs
Dimensions L x H x D	20.5 x 21.5 x 10.1 inch	
Propeller diameter	16.5 inch	
Run time at full speed	20 min	45 min
Engine	600 W with variable speed drive – IP55	
Power supply	Self-contained: NiMH battery On mains: single-phase 110V - 50/60 Hz or 220V - 50/60 Hz	
Electrical safety	Meets EN 50178 for user safety (leakage current less than 3.5 mA)	
Power consumption in steady operation	8A when plugged into 110V 4A when plugged into 220V	
Electric power plug	CE-220V male plug or US-110V male plug	
Charging time	100% in 5 h	100% in 10 h
Use temperature	Use -4°F to +104°F Permanent storage -4°F to +95°F 1 week storage -4°F to +140°F Charging +23°F to +86°F (Charging recommended every 6 weeks)	
Protection	IP55 = protected from water spray in all directions from fire hose	
Noise level	73,5 dB at 10 ft	
Ventilation type	PPV and combined PPV	
Application	Single door – houses, small apartment blocks or as a relay fan on upstairs floors or in attack use in front of an apartment door	

Optional accessories

High expansion foam adapter without coupling delivered with 114.8 ft of polyane plastic film duct (products with coupling: see p. 52)	160.20.105
16.4 ft ventilation duct	160.20.152
Folding transport trolley	163.12.005
330 ft electric extension in bag with lockable EU plugs - weight 26.5 lbs - high-flex cable 3 x AWG 15	163.00.016



ELECTRIC FAN SR460

Auxiliary Relay Fan (ARF)

Lightweight and quiet.

Allows responders to work in complete safety close to the fire, reduce the temperature, and remove hot gases and smoke through vents (windows, etc.).

It is positioned on an upstairs floor as a relay for a more powerful fan positioned at the building entrance (see combined ventilation concept)

Robust protective sheet-steel housing - red epoxy paint

High-strength propeller matched to the power of the motor

Transportable by one operator due to its low weight and small size (with carry handle)

Adjustable tilt angle to optimize the direction of the air stream

Compact, stows easily in the trunk of a vehicle.

Characteristics

Model	SR460
Reference	163.00.015
Open air flow	7,650 CFM
PPV air flow according to AMCA	-
Weight	34.2 lbs
Dimensions L x H x D	22.3 x 21.5 x 16.6 inch
Propeller diameter	15.7 inch
Engine	370 W IP55 protection
Power supply	Single-phase - 230V - 50/60Hz - IP55
Electrical safety	Meets EN 50178 for user safety (leakage current less than 3.5 mA)
Power consumption in steady operation	2.75 A
Mains plug	CE male plug - 220 V
Noise level	65.5 dB at 10 ft
Ventilation type	Combined PPV
Application	As a relay fan on upstairs floors or for attack in front of an apartment door

Optional accessories :

300 ft extension in bag with lockable plugs - weight 26.5 lbs - high-flex cable 3 x AWG 15	163.00.016
--------------------------------------------------------------------------------------------	------------



ELECTRIC FAN ES220



A very **concentrated and ultra-powerful** jet of air due to an optimal combination of:

- ▶ A high-strength propeller matched to the power of the engine
- ▶ A red double-layer monobloc shroud made of reinforced high-density polyethylene
- ▶ A high-tech composite grille

Positioning from 3 ft to 20 ft in front of a door without loss of power for:

- ▶ more space to move about
- ▶ less noise inside the building

Precise tilt adjustment from -10° to +20° with indicator to optimize direction of air stream up entrance steps or down into a semi-basement

Protective frame with gray epoxy coating

Compact for easy storage in vehicle trunks

Characteristics

Model	ES220 NEO
Reference	163.10.039N
Open air flow	18,365 CFM
PPV air flow according to AMCA	12,570 CFM
Weight	57.1 lbs
Dimensions L x H x D	21.6 x 22.4 x 17.2 inch
Propeller diameter	16.5 inch
Engine	1.5 kW
Power supply	220V - 50Hz
Electrical safety	Meets EN 50178 for user safety (leakage current less than 3.5 mA)
Power consumption in steady operation	7.2 A
Mains plug	CE male plug - 220 V
Noise level	86,5 dB at 10 ft
Ventilation type	PPV blowing
Application	Single door, e.g. house, small apartment block

Optional accessories :

Adapter for connecting ventilation duct to fan	160.20.149
16.4 ft ventilation duct	160.20.147
High expansion foam adapter without coupling delivered with 114.8 ft of polyane plastic film duct (products with coupling: see p. 52)	160.20.105
V-BOX cube for extractor/blower kit	163.20.017
16.4 ft duct for V-Box extractor/blower kit - Ø 15.7 inch	163.20.014



NEO
LEADER Fan
EASY POWAIR
TECHNOLOGY



NEO
LEADER Fan
EASY POWAIR
TECHNOLOGY



ELECTRIC FAN ES230 - ESP230 - ESV230

A very **concentrated and ultra-powerful** jet of air due to an optimal combination of:

- ▶ A high-strength propeller matched to the power of the engine
- ▶ A red double-layer monobloc shroud made of reinforced high-density polyethylene
- ▶ A high-tech composite grille

Positioning from 3 ft to 20 ft in front of a door without loss of power for:

- ▶ more space to move about
- ▶ less noise inside the building

Automatic optimal +10° tilt when handle raised

Precise tilt adjustment from +10° to +20° for optimization of direction of air stream up entrance steps

Protective frame with gray epoxy coating

Stable & easy to handle with large rear wheels

Compact for easy storage in vehicle trunks

Characteristics

Model 220 V	ES230 NEO	ESP230 NEO	ESV230 NEO
Reference	I63.10.010N	I63.10.012N	I63.10.011N
Open air flow	23,985 CFM		
PPV air flow according to AMCA	15,975 CFM		
Weight	86.6 lbs	88.2 lbs	90.4 lbs
Dimensions L x H x D	21.6 x 22 x 19.3 inch		
Propeller diameter	16.5 inch		
Engine	2.2 kW single speed drive – IP55	2.2 kW single speed drive with soft starter – IP55	2.2 kW with variable speed drive – IP55
Power supply	Single phase - 230V – 50Hz		Single phase - 230V 50/60Hz – IP55
Electrical safety	Meets EN 50178 for user safety (leakage current less than 3.5 mA)		
Power consumption in steady operation	12,5 A	14 A	16,5 A
Mains plug	CE male plug – 220 V		
Noise level	85,3 dB at 10 ft		
Ventilation type	Blowing – VPP		
Application	Single door – houses, small apartment blocks		

Optional accessories:

Mister without coupling (products with coupling: see p. 52)	I60.20.104	Prop for -10° tilt, useful for ventilating semi-basements	I60.20.130
High expansion foam adapter without coupling delivered with 114.8 ft of polyane plastic film duct (products with coupling: see p. 52)	I60.20.105	16.4 ft duct for V-BOX extractor/blower kit - Ø 15.7 inch	I63.20.014
16.4 ft ventilation duct	I60.20.101	V-BOX cube for extractor/blower kit	I63.20.017
Protective cover	I60.20.017		

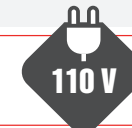

ELECTRIC FAN EDS230 - EDS230.2 - EVG230

A very **concentrated and ultra-powerful** jet of air due to an optimal combination of:

- ▶ A high-strength propeller matched to the power of the engine
- ▶ A red double-layer monobloc shroud made of reinforced high-density polyethylene
- ▶ A high-tech composite grille

Positioning from 3 ft to 20 ft in front of a door without loss of power for:

- ▶ more space to move about
- ▶ less noise inside the building

Precise tilt adjustment from +10° to +20° for optimization of direction of air stream up entrance steps

Protective frame with gray epoxy coating

Stable & easy to handle with large rear wheels

Compact for easy storage in vehicle trunks

Automatic optimal +10° tilt when handle raised

Characteristics

Model 110 V	EDS230 NEO	EDS230.2 NEO	EVG230 NEO
Reference	I63.10.032N	I63.10.033N	I63.10.042N
Open air flow	16,920 CFM	19,070 CFM	17,010 CFM
PPV air flow according to AMCA	11,625 CFM	12,830 CFM	11,625 CFM
Weight	73 lbs	81.6 lbs	78.3 lbs
Dimensions L x H x D	21.6 x 22 x 19.3 inch		
Propeller diameter	16.5 inch		
Engine	1.1 kW single speed drive GFCI compatible – IP55	1.5 kW single speed drive GFCI compatible – IP55	1.1 kW with variable speed drive GFCI compatible – IP55
	Runs on 15 A circuit breaker and compatible with GFCI circuit breaker	Runs on 20 A circuit breaker and compatible with GFCI circuit breaker	Runs on 15 A circuit breaker and compatible with GFCI circuit breaker
Power supply	Single phase - 115V±10% – 60Hz		Single phase - 115V±10% 50/60Hz
Electrical safety	Meets EN 50178 for user safety (leakage current less than 3.5 mA)		
Power consumption in steady operation	13.2 A	18.7 A	13.9 A
Mains plug	US male plug – 110 V		
Noise level	85,2 dB at 10 ft	86,3 dB at 10 ft	85,2 dB at 10 ft
Ventilation type	Blowing – VPP		
Application	Single door – houses, small apartment blocks		

Optional accessories:

High expansion foam adapter without coupling delivered with 114.8 ft of polyane plastic film duct (products with coupling: see p. 52)	I60.20.105	Prop for -10° tilt, useful for ventilating semi-basements	I60.20.130
16.4 ft ventilation duct	I60.20.101	16.4 ft duct for V-BOX extractor/blower kit - Ø 15.7 inch	I63.20.014
Protective cover	I60.20.017	V-BOX cube for extractor/blower kit	I63.20.017

Ventilation tactics in the catalogue or at www.LeaderNorthAmerica.com
Freely downloadable interactive ventilation courses at www.leader.educexpert.com
As part of our policy of constant research to improve our products, we reserve the right to modify our products' characteristics at any time without notice

Ventilation tactics in the catalogue or at www.LeaderNorthAmerica.com
Freely downloadable interactive ventilation courses at www.leader.educexpert.com
As part of our policy of constant research to improve our products, we reserve the right to modify our products' characteristics at any time without notice



ELECTRIC FAN ESX230 - ATEX certified

Usable in an explosive atmosphere

ATEX certification: II 2 GD II B T4 or T135°C according to LCIE 12 ATEX 3043 X

A concentrated, powerful jet of air due to:

- ▶ high-strength propeller matched to the power of the motor
- ▶ double-layer aluminum/ABS thermoplastic red shroud
- ▶ metal grille

Positioning from 3 ft to 20 ft in front of a door without loss of power for:

- ▶ more space to move about
- ▶ less noise inside the building

Automatic optimal +10° tilt when handle raised

Precise tilt adjustment

from +10° to +20° to optimize direction of air stream up entrance steps

Protective frame

with gray epoxy coating

Stable & easy to handle

even on unstable ground due to large rear wheels

Compact

for easy storage in vehicle trunks

Integrated misting system



ELECTRIC FAN ES245 - ESV245

A concentrated, powerful jet of air due to:

- ▶ high-strength propeller matched to the power of the motor
- ▶ double-layer aluminum/ABS thermoplastic red shroud
- ▶ metal grille

Positioning from 3 ft to 20 ft in front of a door without loss of power for:

- ▶ more space to move about
- ▶ less noise inside the building

Automatic optimal +10° tilt when handle raised

Precise tilt adjustment

from +10° to +20° to optimize direction of air stream up entrance steps

Protective frame

with gray epoxy coating

Stable & easy to handle even on unstable ground due to large rear wheels

Characteristics

Model	ESX230
Reference	163.11.006
Open air flow	▶ 17,755 CFM on 50Hz ▶ 21,190 CFM on 60Hz
PPV air flow according to AMCA	11,185 CFM
Weight	125.6 lbs
Dimensions L x H x D	21.6 x 21.6 x 19.3 inch
Propeller diameter	16.5 inch
Engine	1.85 kW – IP65
Power supply	3-phase – 230/400V – 50/60Hz
Electrical safety	Meets EN 50178 for user safety (leakage current less than 3.5 mA)
Engine consumption	3,5 A (in steady operation) and 30 A (starting current)
Mains plug	Not supplied
Integrated misting system	1" BSP F inlet - 4.2 GPM at 100 PSI
Noise level	83.6 dB at 10 ft
Ventilation type	Blowing - PPV in explosive atmosphere
Application	Single door – houses, small apartment blocks, confined spaces, etc.

Optional accessories:

16.4 ft ATEX duct	160.20.099
-------------------	------------

Characteristics

Model	ES245	ESV245
Reference	163.10.017	163.10.015
Open air flow	24,425 CFM	
PPV air flow according to AMCA	16,745 CFM	
Weight	111.3 lbs	116.8 lbs
Dimensions L x H x D	27.9 x 28.3 x 24.3 inch	
Propeller diameter	22.4 inch	
Engine	2,2 kW – IP55	2,2 kW with variable speed drive – IP55
Power supply	220V 50Hz single-phase	220V 50/60Hz single-phase
Electrical safety	Meets EN 50178 for user safety (leakage current less than 3.5 mA)	
Engine consumption	15,5 A	17 A
Mains plug	CE male plug	
Noise level	88.7 dB at 10 ft	
Ventilation type	PPV blowing	
Application	Single door (e.g. houses, small apartment blocks) and double doors (e.g. high-rise tower blocks, mid-size industrial units)	

Optional accessories:

Mister without coupling (products with coupling: see p. 52)	160.20.104	Protective cover	160.20.097
High expansion foam adapter without coupling delivered with 114.8 ft of polyane plastic film duct (products with coupling: see p. 52)	160.20.116	-10° prop for negative tilt of fan	160.20.108
16.4 ft ventilation duct	160.20.113		

Ventilation tactics in the catalogue or at www.LeaderNorthAmerica.com. Freely downloadable interactive ventilation courses at www.leader.educexpert.com. As part of our policy of constant research to improve our products, we reserve the right to modify our products' characteristics at any time without notice.

Ventilation tactics in the catalogue or at www.LeaderNorthAmerica.com. Freely downloadable interactive ventilation courses at www.leader.educexpert.com. As part of our policy of constant research to improve our products, we reserve the right to modify our products' characteristics at any time without notice.



LEADER Fan
EASY POWAIR
TECHNOLOGY



LEADER Fan
EASY POWAIR
TECHNOLOGY

KEY POINTS

Designed for **rapid smoke removal from underground parking lots**. The ParkFan is placed within the smoke-filled volume to blow the smoke out.

Can be controlled from outside the smoke-filled area with a wireless remote control.



ELECTRIC FAN ESP280 - ESV280

A concentrated, powerful jet of air due to:

- ▶ high-strength propeller matched to the power of the motor
- ▶ double-layer aluminum/ABS thermoplastic red shroud
- ▶ metal grille

Positioning from 3 ft to 20 ft in front of a door without loss of power for:

- ▶ more space to move about
- ▶ less noise inside the building

Automatic optimal +10° tilt when handle raised

Precise tilt adjustment

from +10° to +20° to optimize direction of air stream up entrance steps

Protective frame

with gray epoxy coating

Stable & easy to handle even on unstable ground due to large rear wheels



ELECTRIC FAN ParkFan 80

A concentrated, powerful jet of air due to:

- ▶ high-strength propeller matched to the power of the motor
- ▶ double-layer aluminum/ABS thermoplastic red shroud
- ▶ metal grille

Positioning from 3 ft to 20 ft in front of a door without loss of power for:

- ▶ more space to move about
- ▶ less noise inside the building

Automatic optimal +10° tilt when handle raised

Precise tilt adjustment

from +10° to +20° to optimize direction of air stream up entrance steps

Protective frame

with gray epoxy coating

Stable & easy to handle even on unstable ground due to large rear wheels

Integrated misting system

Characteristics

Model	ESP280	ESV280
Reference	I63.10.037	I63.10.038
Open air flow	50,440 CFM	
PPV air flow according to AMCA	-	
Weight	164.5 lbs	179.5 lbs
Dimensions L x H x D	27.9 x 28.3 x 26.7 inch	
Propeller diameter	22.4 inch	
Engine	7.5KW single speed drive with soft starter IP55	7.5KW with variable speed drive* IP65
Power supply	400V 50Hz three-phase	400V 50/60 Hz three-phase
Engine consumption	15.5A	16A
Mains plug	CE male plug – 400 V 32Amp IP67	
Noise level	96.3 dB at 10 ft	
Ventilation type	PPV blowing	
Application	Single door (e.g. houses, small apartment blocks) and double doors (e.g. high-rise tower blocks, mid-size industrial units)	

*If used on an electricity generator, generator must be fitted with a Type B GFCI

Optional accessories:

16.4 ft ventilation duct	I60.20.113	Protective cover	I60.20.097
High expansion foam adapter without coupling delivered with 114.8 ft of polyane plastic film duct (products with coupling: see p. 52)	I60.20.116	-10° prop for negative tilt of fan	I60.20.108

Characteristics

Model	ParkFan 80
Reference	I63.10.045
Open air flow	50,440 CFM
PPV air flow according to AMCA	-
Weight	183 lbs
Dimensions L x H x D	27.9 x 28.3 x 26.7 inch
Propeller diameter	22.4 inch
Engine	7.5KW with variable speed drive IP65*
Power supply	400V 50/60 Hz three-phase
Electrical safety	Meets EN 50178 for user safety (leakage current less than 3.5 mA)
Engine consumption	16A
Mains plug	CE male plug – 400 V 32Amp IP67
Wireless Remote Control	Wireless 2.4 GHz radio remote control for ON/OFF control and speed variation. Range 100 ft
Integrated mister	1" BSP female inlet - 4.2 GPM at 100 PSI
Noise level	96.3 dB at 10 ft
Ventilation type	NPV extraction and PPV blowing

*If used on an electricity generator, generator must be fitted with a Type B GFCI

Optional accessories:

16.4 ft ventilation duct	I60.20.113	-10° prop for negative tilt of fan	I60.20.108
High expansion foam adapter without coupling delivered with 114.8 ft of polyane plastic film duct (products with coupling: see p. 52)	I60.20.116		

Ventilation tactics in the catalogue or at www.LeaderNorthAmerica.com
 Freely downloadable interactive ventilation courses at www.leader.educexpert.com
 As part of our policy of constant research to improve our products, we reserve the right to modify our products' characteristics at any time without notice

Ventilation tactics in the catalogue or at www.LeaderNorthAmerica.com
 Freely downloadable interactive ventilation courses at www.leader.educexpert.com
 As part of our policy of constant research to improve our products, we reserve the right to modify our products' characteristics at any time without notice



ELECTRIC FAN SA 315

Extractor/Blower electric fan

For safe removal of dangerous gases:

- ▶ Ventilation by blowing or extraction
- ▶ With 11.8 inch diam. ZAG couplings for connection to suction and blowing ducts
- ▶ Stainless steel body.

Compact, stows easily in the trunk of a vehicle.

Portable, easy to handle, stable and robust

Characteristics

Model	SA315
Reference	I63.00.022
Nominal air flow	1,505 CFM
Open air flow	5,300 CFM
Weight	65.7 lbs
Dimensions L x H x D	14.7 x 17.1 x 18.1 inch
Outlet grille diameter	11.8 inch
Engine	1.1 kW IP55 protection
Power supply	Single phase - 230V – 50Hz
Electrical safety	Meets EN 50178 for user safety (leakage current less than 3.5 mA)
Power consumption in steady operation	6.1 A
Mains plug	CE male plug – 220 V
Noise level	77 dB at 3 m
Ventilation type	Blowing and Extraction
Application	Smoke or gas removal from premises. Smoke removal from basements and ships

Optional accessories:

Extraction/blowing duct for SA315. Ø 11.8 inch - L 16.4 ft	I61.20.002
------------------------------------------------------------	------------



ELECTRIC FAN SAX320 ATEX certified

Extractor/Blower electric fan

Usable in an explosive atmosphere

ATEX certification: II 2 G II B T4 according to LCIE 13 ATEX 3085 X

For safe removal of dangerous gases:

- ▶ Ventilation by blowing or extraction
- ▶ With 300mm diam. ZAG couplings for connection to suction and delivery ducts
- ▶ Stainless steel body.

Compact, stows easily in the trunk of a vehicle.

Portable, easy to handle, stable and robust

Characteristics

Model	SAX320	SAX320 MN	SAX320 MNT
Reference	I63.00.006	I63.00.007	I63.00.012
Nominal air flow	1,505 CFM	1,810 CFM	1,505 CFM on 50Hz 1,810 CFM on 60Hz
Air flow in extraction	1,855 CFM	2,235 CFM	1,855-2,235 CFM
Open air flow	5,300 CFM	6,360 CFM	5,300-6,360 CFM
Weight	92.6 lbs		
Dimensions L x H x D	14.7 x 23 x 20.5 inch		
Outlet grille diameter	11.8 inch		
Engine	1.1 kW Protection IP55 – ATEX: II 2 G II B T4 (Other motor: consult us)		
Power supply	Single-phase - 230V 50-60Hz	Three-phase - 115V 60Hz	Single-phase - 230V 50/60Hz Tropicalized
Electrical safety	Meets EN 50178 for user safety (leakage current less than 3.5 mA)		
Power consumption in steady operation	4,5 A	8 A	4,5 A
Mains plug	Not supplied		
Noise level	77 dB at 3 m		
Ventilation type	Blowing and Extraction		
Application	Dilution of explosive atmosphere. Chemical vapor removal by extraction. Tank degassing.		

Optional accessories:

Antistatic PVC extraction/blowing duct for SAX320. Ø 11.8 inch - L 16.4 ft	I61.20.011
----------------------------------------------------------------------------	------------

Ventilation tactics in the catalogue or at www.LeaderNorthAmerica.com
 Freely downloadable interactive ventilation courses at www.leader.educexpert.com
 As part of our policy of constant research to improve our products, we reserve the right to modify our products' characteristics at any time without notice

Ventilation tactics in the catalogue or at www.LeaderNorthAmerica.com
 Freely downloadable interactive ventilation courses at www.leader.educexpert.com
 As part of our policy of constant research to improve our products, we reserve the right to modify our products' characteristics at any time without notice



Water-driven fans



These must be connected to a pump to operate. They are used for special situations or in the context of particular working modes where electric or gasoline-driven fans cannot be used.



NEO
LEADER Fan
EASY POW'AIR
TECHNOLOGY

WATER-DRIVEN FAN MH236

A very **concentrated and ultra-powerful** jet of air due to an optimal combination of:

- ▶ A high-strength propeller matched to the power of the engine
- ▶ A red double-layer monobloc shroud made of reinforced high-density polyethylene
- ▶ A high-tech composite grille

Positioning from 3 ft to 20 ft in front of a door without loss of power for:

- ▶ more space to move about
- ▶ less noise inside the building

Automatic optimal +10° tilt when handle raised

Precise tilt adjustment from +10° to +20° for optimization of direction of air stream up entrance steps

Protective frame with gray epoxy coating

Stable & easy to handle even on unstable ground due to large rear wheels

Compact for easy storage in vehicle trunks

Integrated misting system

Characteristics

Model	MH236 NEO
Reference	I61.00.034N
Open air flow	28,870 CFM
PPV air flow according to AMCA	-
Weight (dry)	71.9 lbs
Dimensions L x H x D	21.6 x 22 x 19.3 inch
Propeller diameter	16.5 inch
Engine	Water-driven motor in aluminum with DSP 65 coupling, cutoff and control valve, and pressure gage
Engine power	9 HP
Power supply	Water under pressure
Engine consumption	165 GPM @ 145 PSI
Engine supply couplings	2" male for inlet and outlet
Integrated misting system	Yes
Noise level	92.8 dB at 10 ft
Ventilation type	PPV blowing
Application	Single door – houses, small apartment blocks

Optional accessories:

16.4 ft ventilation duct	I60.20.101	Protective cover	I60.20.017
High expansion foam adapter without coupling delivered with 114.8 ft of polyane plastic film duct (products with coupling: see p. 52)	I60.20.105	-10° prop for negative tilt of fan	I60.20.130



LEADER Fan
EASY POW'AIR
TECHNOLOGY

WATER-DRIVEN FAN MH260

A **concentrated, powerful** jet of air due to:

- ▶ high-strength propeller matched to the power of the motor
- ▶ double-layer aluminum/ABS thermoplastic red shroud
- ▶ metal grille

Positioning from 3 ft to 20 ft in front of a door without loss of power for:

- ▶ more space to move about
- ▶ less noise inside the building

Automatic optimal +10° tilt when handle raised

Precise tilt adjustment from +10° to +20° for optimization of direction of air stream up entrance steps

Protective frame with gray epoxy coating

Stable & easy to handle even on unstable ground due to large rear wheels

Integrated misting system

Characteristics

Model	MH260
Reference	I61.00.037
Open air flow	29,725 CFM
PPV air flow according to AMCA	-
Weight (dry)	108 lbs
Dimensions L x H x D	27.9 x 28.3 x 24.3 inch
Propeller diameter	22.4 inch
Engine	Water-driven motor in aluminum with cutoff and control valve. With pressure gage
Engine power	9 HP
Power supply	Water under pressure
Engine consumption	165 GPM @ 145 PSI
Engine supply couplings	2" male for inlet and outlet
Integrated misting system	Yes
Noise level	92.8 dB at 10 ft
Ventilation type	PPV blowing
Application	Single door (e.g. house, small apartment block) and double door (e.g. tall apartment block, mid-size industrial unit)

Optional accessories:

16.4 ft ventilation duct	I60.20.113	Protective cover	I60.20.097
High expansion foam adapter without coupling delivered with 114.8 ft of polyane plastic film duct (products with coupling: see p. 52)	I60.20.116	-10° prop for negative tilt of fan	I60.20.108



Large-Flow Ventilators



These fans are mobile solutions for ventilating large or even very large volumes, e.g. Warehouses, Tunnels, Airports, Industrial Complexes, High-Rise Tower Blocks, etc.



LARGE-FLOW VENTILATOR EASY 2000

Mobile large-volume ventilation system

The most powerful large-flow ventilator in its category for smoke removal and cooling in large volumes (covered / closed parking lots, warehouses, production line, exhibition halls, etc...)

Very powerful airflow: 88,290 CFM
2 versions available for varied configurations:

- ▶ On Skid
 - movable and usable with forklift truck
 - mounted on trolley or similar
 - can be mounted on bed of vehicle, e.g. pickup truck
- ▶ Trailer-mounted

Extremely low weight for ease of deployment

- ▶ Less than 397 lbs for the skid version
- ▶ Less than 716 lbs for the trailer version

A motor control panel and a wired remote control for tilt, elevation and lighting according to selected options

Two possible elevation platforms (23.6 inch or 47.2 inch) on lifting table controlled by wired remote control

Electric tilt of shroud from -10° to +20° controlled by wired remote control



Characteristics

Model	EASY 2000 on trailer			Skid EASY 2000		
Lift system	Without	23.6 inch	47.2 inch	Without	23.6 inch	47.2 inch
References	I60.30.124	I60.30.123	I60.30.120	I60.30.121	I60.30.125	I60.30.126
Open air flow	88,290 CFM					
Propeller diameter	34.8 inch					
Height - inch	67.5	75.4	80.7	49.2	59.5	64.8
Width - inch	56.3	56.3	56.3	41.7	41.7	41.7
Length - inch	110.2	110.2	110.2	47.4	47.4	47.4
Weight - lbs dry	663.6	886.3	985.5	348.3	606.3	705.5
Weight - lbs in running mode	714.3	937	1,036.2	392.4	650.4	749.6
Mounting	Single-axle trailer with brakes, towball and sealed enclosure			Skid on red epoxy-painted steel chassis adaptable to bed of trailer, pick-up, truck, etc. (all delivered on pallet)		
Engine control panel	Mounted on the engine. Allows the operator to control: <ul style="list-style-type: none"> ▶ the starter ▶ electrical start/stop ▶ fan flow rate via the accelerator ▶ rpm and hour-run time via the hour meter ▶ oil level (warning light) 					
Wired remote control	Control, from as far as 33 ft away: <ul style="list-style-type: none"> ▶ the tilt of the shroud from -10° to +20° ▶ the rise and fall of the lifting table depending on the selected option ▶ engine stop ▶ turn LED spotlight on/off 					
Misting system	For water or water+additive(s) – 65 GPM @ 100 PSI					
Engine	HONDA GX630					
Engine power	20.8 HP					
Tank	4.8 Gallon					
Fuel	unleaded gasoline 95					
Runtime	3h05 min					
Oil	Engine oil: 5W-30 synthetic API SJ or later (CASTROL MAGNATEC) Hydraulic oil for lifting option: CASTROL SAF XJ 75-140					
Battery	12V / 44 Ah battery to power the electrical equipment					
Noise level	93.9 dB at 23 ft					
Use	PPV					
Application	Ventilating underground parking lots, industrial sites, warehouses, tunnels, etc.					

Optional accessories :

Manual 360° rotation system	For Skid version only. Add +10.4 inch height and +154.3 lbs	I60.30.129
Exhaust extension	L 8.2 ft / Ø 2 inch Tip: use 3 exhaust extensions end to end for more efficiency	I60.30.003
Adapter for exhaust extension	For connecting the exhaust extension	I60.30.128
Trolley	Aluminum trolley with handle and brake system for easy movement of the Skid EASY 2000 (without lift system). L 4 x D 2.6 x H 3.6 ft	I60.30.119
LED headlight	For illuminating the blowing area	I60.30.130
Blowing duct	236.2 ft / Ø 35.4 inch	I60.30.122
Gasoline (petrol) tank for trailer	5.3 Gallon jerry can on galvanized steel mounting	I60.30.131
Ring Hitch (height-adjustable drawbar)	Allows trailer to be hitched with a ring system (over 154.3 lbs necessitating a vehicle registration certificate depending on country of registration)	I60.30.132



LARGE-FLOW VENTILATOR EASY 4000

Mobile large-volume ventilation system

A very effective solution for smoke removal and air cooling and renewal in large spaces (parking lots, tall apartment blocks, factories, storage facilities, exhibition venues, etc.)

Very powerful airflow: 235,430 CFM

Very stable and extremely light for easy deployment

- ▶ Unrivalled combination of performance and maneuverability

Large

47.2 inch diameter shroud with -10° to +20° tilt controlled from the control panel

With water or water+additive(s) misting system:

- ▶ 65 GPM @ 100 PSI
- ▶ Range: up to 197 ft

Possible configurations:

- ▶ On trailer
 - one person can easily position the trailer
 - total maximum weight less than 1600 lbs: Can be drawn by a light vehicle (European 'B' driver's license sufficient)
- ▶ On skid for installation on bed or vehicle (pick-up, truck, tank, railroad-going platform, etc.)



SKID VERSION

Characteristics

Model	EASY 4000 on trailer			Skid EASY 4000		
Lift system	Without	23.6 inch	47.2 inch	Without	23.6 inch	47.2 inch
Reference	160.30.113	160.30.114	160.30.109	160.30.110	160.30.111	160.30.112
Open air flow	234,430 CFM					
Nominal air flow	108,890 CFM					
Propeller diameter	47.2 inch					
Height - inch	87.2	86 to 109.6	91.1 to 138.4	63.7	70.4 to 94.1	75.7 to 122.9
Width - inch	66.5	66.5	66.5	58	58	58
Length - inch	129.9	129.9	129.9	71.2	71.2	71.2
Dry weight - lbs	1,203.7	1,426.39	1,525.6	820.1	1,042.8	1,142
Weight in running order - lbs	1,276.5	1,500	1,598.3	892.9	1,115.5	1,214.7
Support	Trailer type-approved to European standards: AL-KO chassis / Tow ball (adjustable shaft and/or ring optional) / Wheel chocks for positioning when fan is running / Battery charger / 22.7 Gallon storage box <i>Registration may be required depending on the user's country</i>			Steel chassis painted in black epoxy <i>(all delivered on pallet)</i>		
Control panel	Mounted on the trailer / Protective cover supplied Ingress protection: IP55			Mounted on support (steel painted in red epoxy) Protective cover supplied / Ingress protection: IP55		
Control panel	Allows control of <ul style="list-style-type: none"> ▶ engine start and stop ▶ tilt of shroud from -10° to +20° ▶ airflow by adjusting the fan speed ▶ raising and lowering the lifting table depending on selected option ▶ emergency simultaneous engine stop, tilt and/or table rise 					
Misting system	For water or water+additive(s) – 65 GPM @ 100 PSI – Inlet supply 1.5 inch NST					
Engine	BMW Flat Twin with catalytic converter - 1170 cm3 with electronic control - 115 HP – 2 cylinders – 4-stroke Electric start – Fuel consumption: 25 L/hour at full speed - Cooling: Air/Oil					
Tank	11 Gallon					
Fuel	unleaded gasoline 95					
Runtime	1h40min					
Oil	Engine oil: 1 gal – API SL / Hydraulic oil for raising table option: 0.2 gal – ISO32					
Battery	Rapid charge 12V / 15 Ah battery to power the electrical equipment					
Noise level	96 dB at 23 ft					
Use	PPV					
Application	Ventilating underground parking lots, industrial sites, warehouses, tunnels, high rise buildings, etc.					

Optional accessories :

Wired remote control	Control from up to 42.6 ft away: <ul style="list-style-type: none"> ▶ the tilt of the shroud from -10° to +20° ▶ airflow by adjusting the fan speed ▶ raising and lowering the lifting table depending on selected option ▶ engine stop 	160.30.118
Manual 360° rotation system	For Skid version only. Add +6.9 inch height and +154.3 lbs	160.30.010
Protective cover	For trailer version only.	160.30.004
Exhaust extension	L 8.2 ft / Ø 3.1 inch - Tip: use 3 extensions end to end for more efficiency	160.30.003
Adapter for exhaust extension	For connecting the exhaust extension	160.30.017
Blowing duct	For channeling the air stream of the EASY 4000 in a straight line L 39.4 ft – Ø 5.6 ft – Outlet cross section 3.6 ft – 88.2 lbs	160.30.016
Extraction duct	Up to 6 ducts can be interconnected. 1 duct = Ø 22.6 inch / L 19.7 ft / 41.9 lbs	160.30.019

Ventilation tactics in the catalogue or at www.LeaderNorthAmerica.com
 Freely downloadable interactive ventilation courses at www.leader.educexpert.com
 As part of our policy of constant research to improve our products, we reserve the right to modify our products' characteristics at any time without notice



Ventilation accessories



Blowing ducts, extraction ducts, high-expansion foam adapter, misting nozzles, etc. are options that increase the number of ways a fan can be used and so circumvent the constraints of a given operation.



VENTILATION ACCESSORIES DUCTS

V-BOX: EXTRACTOR/BLOWER CONVERSION KIT

- ▶ The simple solution for:
 - converting an electric fan into a powerful cold smoke extractor
 - channel the air stream to ventilate confined spaces
- ▶ The ventilator is placed inside the V-Box cube in the desired direction of the airstream (extracting or blowing).
- ▶ The ducts quickly connect to the V-Box.
- ▶ Usable with multiple ducts upstream as well as downstream.
- ▶ Carry handles enable it to be used for transporting and protecting the fan.
- ▶ Base reinforced with plastic skids allowing it to be dragged.



Ductless V-Box cube

Reference	Characteristics	Adaptable to these fans:
163.20.017	Red polyester and polypropylene cube with integrated rigid structure – With 2 male quick closures - Dim. H 22.8 x L 25.2 x D 20.1 inch - 7.7 lbs	
163.20.014	M1 duct for V-Box cube with male & female quick couplings - Ø 15.7 inch / L 16.4 ft / 25.3 lbs	Electric : ES220 / ES230 / ESP230 / ESV230 / EDS230 / EVG 230
163.20.016	ZAG adaptor: with female quick clasp for locating on end of duct or directly on the V-BOX Cube - 3.2 lbs	



V-Box in blowing mode



V-Box in extraction mode



Complete V-Box

LFV BLOWING DUCT

For channeling the air stream in a straight line



Reference	Characteristics	Adaptable to these fans:
160.30.016	Ø 67 inch / Ø output 43.3 inch / L 39.4 ft / 88.2 lbs	LFV: EASY 4000
160.30.122	Ø 35.4 inch / L 16.4 ft	LFV: EASY 2000

LFV EXTRACTION DUCT

For extracting smoke from large volumes.

Set of 3 ducts giving a total length of 59.1 ft - No bulky adapter between duct and fan
Ability to interconnect up to 6 ducts - Integrated carrying bag.

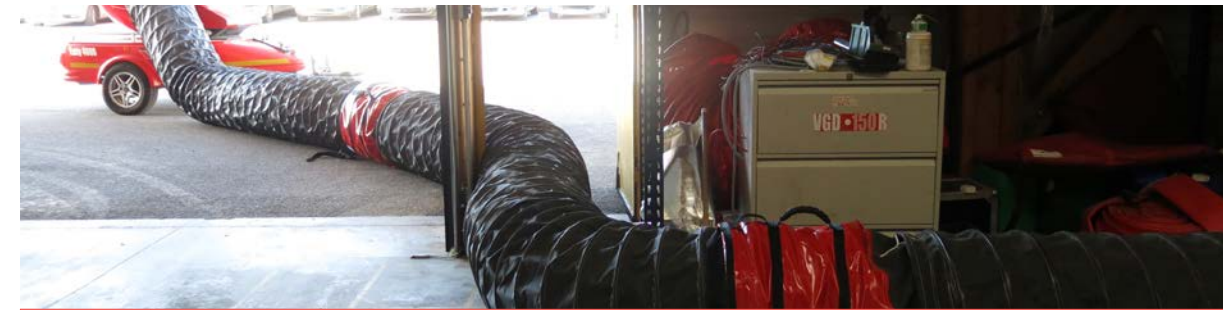

Reference	Characteristics	Adaptable to these fans:
160.30.019	1 duct Ø 22.6 inch / L 29.8 ft / 41.9 lbs	LFV: EASY 4000

VENTILATION DUCT

Excellent for channeling fan air or extracting smoke in complex operations!

Reference	Characteristics	Adaptable to these fans:
160.20.152	Ø 16.9 inch / L 16.4 ft / 28.6 lbs	Gasoline-driven: MT215L / MT225 / MT236 / MT240 Electric: BATfan / ES220 / ES230 / ESP230 / ESV230 / EDS230 / EVG230 Water-driven: MH236
160.20.113	Ø 23.6 inch / L 16.4 ft / 38.6 lbs	Gasoline-driven: MT245 / MT280 / MT296 Electric: ES245 / ESV245 / ESP280 / ESV280 / ParkFan80 Water-driven: MH260
161.20.002	Ø 11.8 inch / L 16.4 ft / 28.2 lbs	Electric: SA315
161.20.011	ATEX / Ø 11.8 inch / L 16.4 ft / 28.9 lbs	Atex: SAX320
160.20.099	ATEX / Ø 430 mm / L 16.4 ft / 27.5 lbs	Atex: ESX230



160.20.152

VENTILATION ACCESSORIES OPTIONS FOR FANS

MISTER

Offers the possibility of faster, more effective cooling
Flow rate 4.2 GPM at 100 PSI



Reference	Characteristics	Adaptable to these fans:
On request	without coupling — inlet 1.5 inch NH F	Gasoline-driven: MT236 / MT240 / MT245 / MT280
160.20.104	without coupling — inlet 1 inch BSP F	Electric: ES230 / ESP230 / ESV230 / ES245 / ESV245 / ESP280 / ESV280
160.20.107	with GFR20 coupling	
160.20.114	with BCN coupling	
On request	without coupling — inlet 1.5 inch NH F	Gasoline-driven: MT296
160.20.111	without coupling — inlet 1 inch BSP F	
160.20.118	with GFR20 coupling	
160.20.122	with BCN coupling	

HI-EXPANSION FOAM ADAPTER

Converts the fan into a high-expansion foam generator
Expansions from 400 to 800 - Works with an in-line proportioner at 53 GPM - Delivered with 114.8 ft of polyane plastic film duct



Reference	Characteristics	Adaptable to these fans:
On request	without coupling — inlet 1.5 inch NH F	Gasoline-driven: MT215L / MT225 / MT236 / MT240
160.20.105	without coupling — inlet 1.5 inch BSP M	Electric: BATfan / ES220 / ES230 / ESP230 / ESV230 / EDS230 / EVG230
160.20.103	with DSP40 coupling	Water-driven: MH236
160.20.106	with BCN coupling	
160.20.124	with BIC coupling	
On request	without coupling — inlet 1.5 inch NH F	Gasoline-driven: MT245 / MT280 / MT296
160.20.116	without coupling — inlet 1.5 inch BSP M	Electric: ES245 / ESV245 / ESP280 / ESV280 / ParkFan80
160.20.117	with DSP40 coupling	Water-driven: MH260
160.20.121	with BCN coupling	
160.20.123	with BIC coupling	

HOUR METER

Shows the engine rpm and hours-run time of gasoline-driven fans.



Reference	Characteristics	Adaptable to these fans:
160.20.135	—	Gasoline-driven: MT215L / MT236 / MT245 / MT280 / MT296 / MT240

EXHAUST EXTENSION

For expelling exhaust gases outside of room where fan is operating or far from extraction area, in order to limit the introduction of gases such as CO.
Complies with DIN 14-572.



Reference	Characteristics	Adaptable to these fans:
160.20.012	L 8.2 ft / Ø 2 inch	Gasoline-driven: MT236 / MT240 / MT245 / MT280 / MT296 / LFV EASY 2000
160.30.003	L 8.2 ft / Ø 3.1 inch	LFV: EASY 4000

EXHAUST ADAPTER

For connecting the exhaust extension



Reference	Characteristics	Adaptable to these fans:
160.20.014	for Honda engines	Gasoline-driven: MT236 / MT240 / MT245
160.20.125	for Honda engines	Gasoline-driven: MT280
-	Integrated with the machine	Gasoline-driven: MT296
160.30.017	for BMW engine	LFV: EASY 4000

CO-REDUCING CATALYTIC CONVERTER

Reduces majority of CO emissions from Honda GX160 and GX200 engines through use of the LEADER Cat converter.
Compatible with exhaust extensions.



Reference	Characteristics	Adaptable to these fans:
160.20.142	Stainless steel body – 0.9 lbs – Dim. L 3.3 x W 2.4 x D 2.8 inch	Gasoline-driven: MT236 / MT240 / MT245

-10° PROP

Allows a negative tilt (-10°) for ventilating downwards or into a semi-basement.



160.20.130



Reference	Characteristics	Adaptable to these fans:
160.20.130	1.1 lbs - Stainless steel tubing to be fixed on the protective frame	Gasoline-driven: MT236 Electric: ES230 / ESP230 / ESV230 / EDS230 / EVG230 Water-driven : MH236
160.20.108	1.1 lbs - Stainless steel tubing	Gasoline-driven: MT245 / MT280 / MT296 Electric: ES245 / ESV245 / ESP280 / ESV280 / ParkFan80 Water-driven: MH260

160.20.108

EXTENSION CABLE

Extra-flexible cable coiled in a bag designed to unwind without tangling and with lockable plugs.



Reference	Characteristics	Adaptable to these fans:
163.00.016	L 330 ft with lockable 220V plugs / 26.5 lbs	Electric: BATfan / SR460

20,000 VOLT INSULATING TELESCOPIC PIKE-POLE

Ideal for making heat and smoke vents.
Extendable, fiberglass. Can be locked at any length.
Body complies with IEC 61235 and IEC 60855



Reference	Characteristics
020.00.116	Length: retracted 7.2 ft / extended 147.6 ft Ø 1.5 inch - 6.6 lbs Elongation resistance of the pike pole lockable system: 220 lbs

DOOR WEDGE

Can be placed in different positions on a door to keep it open.



Reference	Characteristics
160.20.112	Plastic

PROTECTIVE COVER

Protects the fan when unused.



Reference	Adaptable to these fans:
160.20.017	Gasoline-driven: MT236 / MT240 Electric: ES230 /ESP230 / ESV230 Water-driven: MH236
160.20.097	Gasoline-driven: MT245 / MT260 / MT280 / MT296 Electric: ESP280 / ESV280 Water-driven: MH260



WARRANTY

LEADER guarantees the LEADER Fan range of equipment from the date of acceptance by the customer.

The respective warranty periods are as follows:

- ▶ Portable fans = 6 years (2 years for electric motor)
- ▶ Easy 2000 = 1 year
- ▶ Easy 4000 = 1 year
- ▶ Accessories (mister, hour meter, V-Box, LEADER Cat, foam adapter, etc.) = 1 year
- ▶ Batteries = 6 months

This warranty does not apply where it has been found by our services that the equipment was damaged by:

- ▶ Normal wear due to operation
- ▶ Improper use of the equipment
- ▶ Accidents arising from carelessness
- ▶ Poor maintenance
- ▶ Failure to follow the standards and instructions of the manufacturer
- ▶ Improper storage

Consumables, such as feet, cables, blowing or extraction ducts, paint and labels, filters, spark plug, oil, wheels, seals, bulbs, etc. are excluded from this warranty if defects are discovered after using the product.



OUR CLOSE RELATIONSHIPS WITH OUR CUSTOMERS HELP US DESIGN THE PRODUCTS OF **TOMORROW**



Fire extinction



Mobile ventilation



Thermal imaging



Fire training equipment



Search and Rescue equipment



Foam concentrates & foam proportioning

LEADER NORTH AMERICA Inc.
109-A Summerville Drive, Mooresville, NC 28115 - U.S.A
Tel: 704-662-3377 – Fax: 704-662-3397
info@LeaderNorthAmerica.com

LEADER GmbH
Zur Fabrik 10 - 66271 Kleinblittersdorf - Germany
Tel. : +49 (0) 6805/60067-0 - Fax : +49 (0) 6805/60067-10
info@leader-gmbh.de

GROUPE LEADER S.A.S.
ZI des Hautes-Vallées - Chemin n° 34 - CS20014 - 76930 Octeville sur Mer - France
Tel +33 (0)2.35.53.05.75 - Fax +33 (0)2.35.53.16.32
info@leader-group.eu

SPAIN / PORTUGAL / LATIN AMERICA
spain.portugal.latinamerica@leader-group.eu

CHINA / HONG KONG / MACAU
china@leader-group.eu

www.LeaderNorthAmerica.com